

CAMBRIDGE INTERNATIONAL EXAMINATIONS
General Certificate of Education
Advanced Subsidiary Level and Advanced Level

PHYSICS

9702/01

Paper 1 Multiple Choice

October/November 2003

1 hour

Additional Materials: Multiple Choice Answer Sheet
Soft clean eraser
Soft pencil (type B or HB is recommended)

READ THESE INSTRUCTIONS FIRST

Write in soft pencil.

Do not use staples, paper clips, highlighters, glue or correction fluid.

Write your name, Centre number and candidate number on the Answer Sheet in the spaces provided unless this has been done for you.

There are **forty** questions on this paper. Answer **all** questions. For each question there are four possible answers **A, B, C, and D**.

Choose the **one** you consider correct and record your choice in **soft pencil** on the separate Answer Sheet.

Read the instructions on the Answer Sheet very carefully.

Each correct answer will score one mark. A mark will not be deducted for a wrong answer.

Any rough working should be done in this booklet.

This document consists of **17** printed pages and **3** blank pages.



Data

speed of light in free space,	$c = 3.00 \times 10^8 \text{ m s}^{-1}$
permeability of free space,	$\mu_0 = 4\pi \times 10^{-7} \text{ H m}^{-1}$
permittivity of free space,	$\epsilon_0 = 8.85 \times 10^{-12} \text{ F m}^{-1}$
elementary charge,	$e = 1.60 \times 10^{-19} \text{ C}$
the Planck constant,	$h = 6.63 \times 10^{-34} \text{ J s}$
unified atomic mass constant,	$u = 1.66 \times 10^{-27} \text{ kg}$
rest mass of electron,	$m_e = 9.11 \times 10^{-31} \text{ kg}$
rest mass of proton,	$m_p = 1.67 \times 10^{-27} \text{ kg}$
molar gas constant,	$R = 8.31 \text{ J K}^{-1} \text{ mol}^{-1}$
the Avogadro constant,	$N_A = 6.02 \times 10^{23} \text{ mol}^{-1}$
the Boltzmann constant,	$k = 1.38 \times 10^{-23} \text{ J K}^{-1}$
gravitational constant,	$G = 6.67 \times 10^{-11} \text{ N m}^2 \text{ kg}^{-2}$
acceleration of free fall,	$g = 9.81 \text{ m s}^{-2}$

Formulae

uniformly accelerated motion,	$s = ut + \frac{1}{2}at^2$ $v^2 = u^2 + 2as$
work done on/by a gas,	$W = p\Delta V$
gravitational potential,	$\phi = -\frac{Gm}{r}$
simple harmonic motion,	$a = -\omega^2x$
velocity of particle in s.h.m.,	$v = v_0 \cos \omega t$ $v = \pm \omega \sqrt{(x_0^2 - x^2)}$
resistors in series,	$R = R_1 + R_2 + \dots$
resistors in parallel,	$1/R = 1/R_1 + 1/R_2 + \dots$
electric potential,	$V = \frac{Q}{4\pi\epsilon_0 r}$
capacitors in series,	$1/C = 1/C_1 + 1/C_2 + \dots$
capacitors in parallel,	$C = C_1 + C_2 + \dots$
energy of charged capacitor,	$W = \frac{1}{2}QV$
alternating current/voltage,	$x = x_0 \sin \omega t$
hydrostatic pressure,	$p = \rho gh$
pressure of an ideal gas,	$p = \frac{1}{3} \frac{Nm}{V} \langle c^2 \rangle$
radioactive decay,	$x = x_0 \exp(-\lambda t)$
decay constant,	$\lambda = \frac{0.693}{t_{\frac{1}{2}}}$
critical density of matter in the Universe,	$\rho_0 = \frac{3H_0^2}{8\pi G}$
equation of continuity,	$Av = \text{constant}$
Bernoulli equation (simplified),	$p_1 + \frac{1}{2}\rho v_1^2 = p_2 + \frac{1}{2}\rho v_2^2$
Stokes' law,	$F = Ar\eta v$
Reynolds' number,	$Re = \frac{\rho v r}{\eta}$
drag force in turbulent flow,	$F = Br^2\rho v^2$

- 1 A student measures a current as 0.5 A.

Which of the following correctly expresses this result?

- A** 50 mA **B** 50 MA **C** 500 mA **D** 500 MA

- 2 A force of 5 N may be represented by two perpendicular components OY and OX as shown in the diagram, which is **not** drawn to scale.

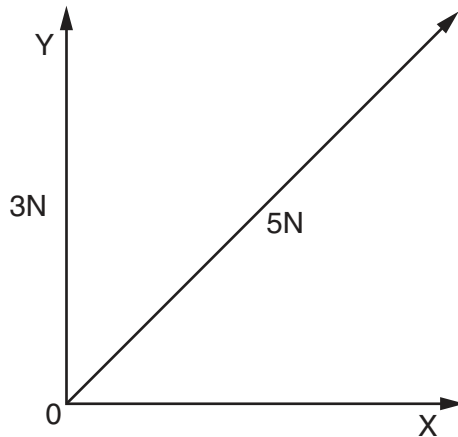

OY is of magnitude 3 N.

What is the magnitude of OX?

- A** 2 N **B** 3 N **C** 4 N **D** 5 N

- 3 The momentum of an object of mass m is p .

Which quantity has the same base units as $\frac{p^2}{m}$?

- A** energy
B force
C power
D velocity

- 4 A thermometer can be read to an accuracy of $\pm 0.5^\circ\text{C}$. This thermometer is used to measure a temperature rise from 40°C to 100°C .

What is the percentage uncertainty in the measurement of the temperature rise?

- A** 0.5% **B** 0.8% **C** 1.3% **D** 1.7%

- 5 The time-base on a cathode-ray oscilloscope is set at 6 ms/cm.

A trace consisting of two pulses is recorded as shown in the diagram.

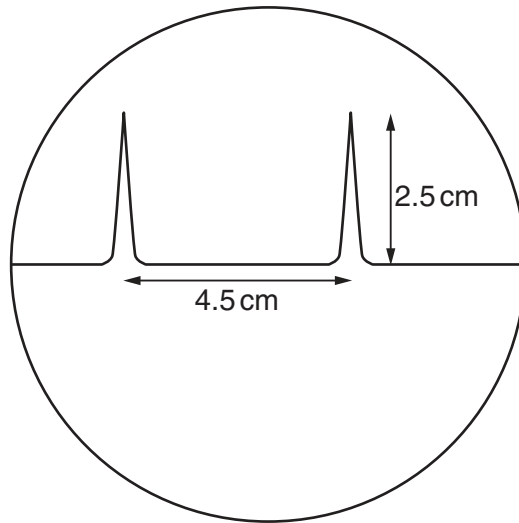

What is the time interval between the two pulses?

- A** 0.42 ms **B** 0.75 ms **C** 1.33 ms **D** 27 ms
- 6 A micrometer screw gauge is used to measure the diameter of a copper wire.

The reading with the wire in position is shown in diagram 1. The wire is removed and the jaws of the micrometer are closed. The new reading is shown in diagram 2.

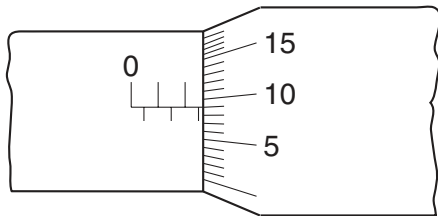

diagram 1

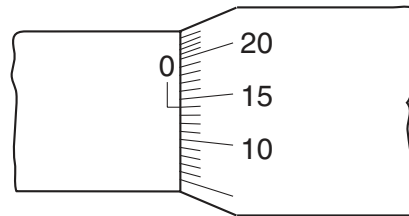
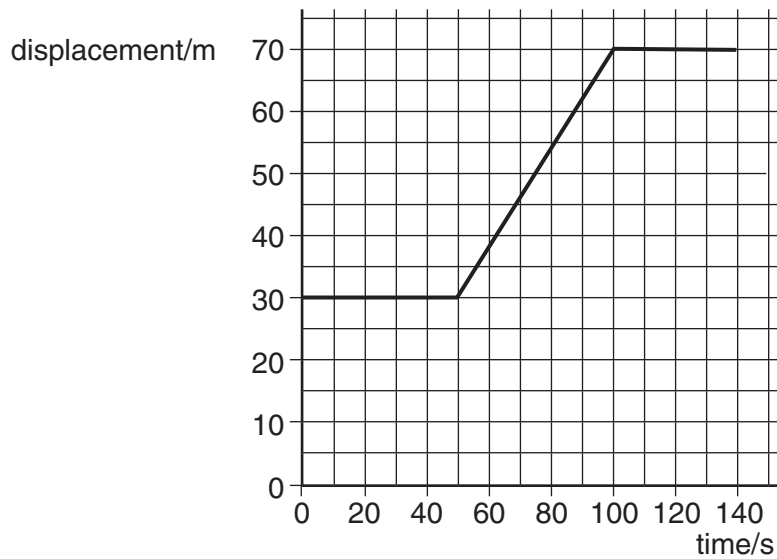

diagram 2

What is the diameter of the wire?

- A** 1.90 mm **B** 2.45 mm **C** 2.59 mm **D** 2.73 mm

- 7 A car at rest in a traffic queue moves forward in a straight line and then comes to rest again. The graph shows the variation with time of its displacement.



What is its speed while it is moving?

- A** 0.70 m s^{-1} **B** 0.80 m s^{-1} **C** 1.25 m s^{-1} **D** 1.40 m s^{-1}
- 8 An object is dropped from a great height and falls through air of uniform density.

The acceleration of free fall is g .

Which graph could show the variation with time t of the acceleration a of the object?

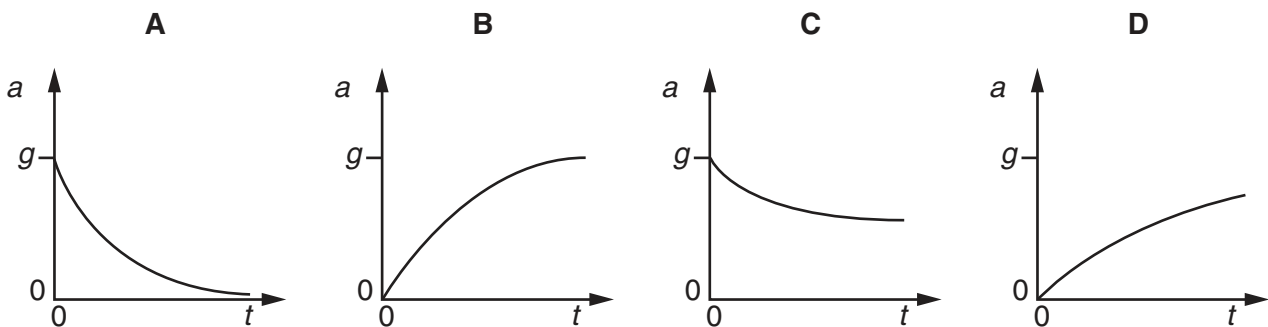

- 9 Which of the following is a statement of the principle of conservation of momentum?
- A** Momentum is the product of mass and velocity.
B In an elastic collision, momentum is constant.
C The momentum of an isolated system is constant.
D The force acting on a body is proportional to its rate of change of momentum.

- 10 A mass accelerates uniformly when the resultant force acting on it
- A is zero.
 B is constant but not zero.
 C increases uniformly with respect to time.
 D is proportional to the displacement from a fixed point.
- 11 A molecule of mass m travelling horizontally with velocity u hits a vertical wall at right angles to the wall. It then rebounds horizontally with the same speed.

What is its change in momentum?

- A zero B mu C $-mu$ D $-2mu$
- 12 Two balls X and Y approach each other along the same straight line and collide elastically. Their speeds are u_X and u_Y respectively. After the collision they move apart with speeds v_X and v_Y respectively. Their directions are shown on the diagram.

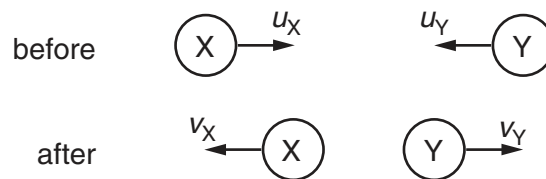

Which of the following equations is correct?

- A $u_X + u_Y = v_X + v_Y$
 B $u_X + u_Y = v_X - v_Y$
 C $u_X - u_Y = v_X + v_Y$
 D $u_X - u_Y = v_X - v_Y$

- 13 A spanner is used to tighten a nut as shown.

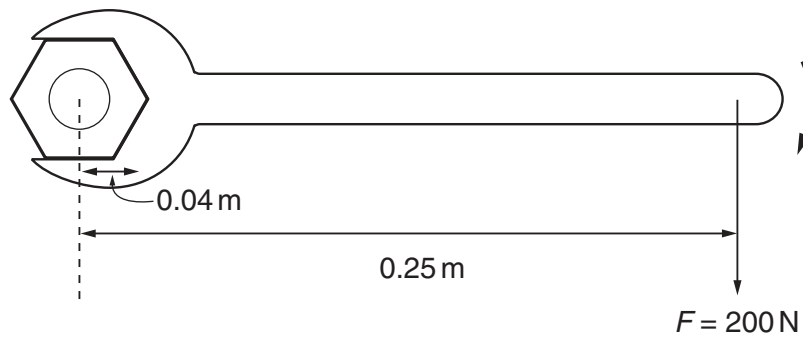

A force F is applied at right-angles to the spanner at a distance of 0.25 m from the centre of the nut. When the nut is fully tightened, the applied force is 200 N.

What is the resistive torque, in an anticlockwise direction, preventing further tightening?

- A 8 Nm
 - B 25 Nm
 - C 50 Nm
 - D 800 Nm
- 14 Two parallel forces, each of magnitude F , act on a body as shown.

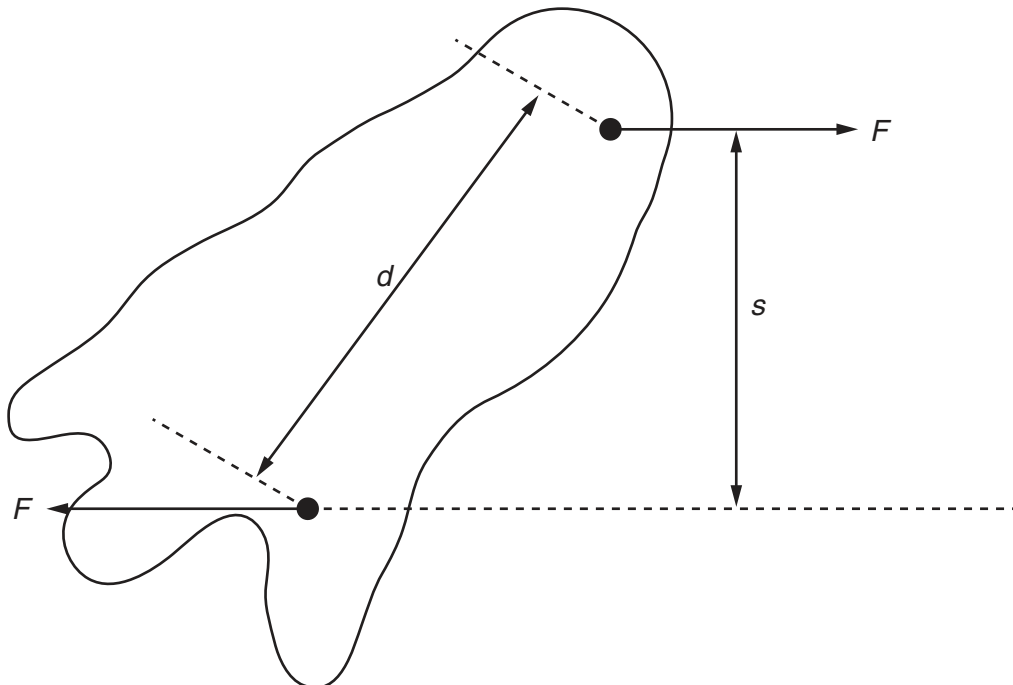

What is the magnitude of the torque on the body produced by these forces?

- A Fd
- B Fs
- C $2Fd$
- D $2Fs$

- 15 A force F is applied to a freely moving object. At one instant of time, the object has velocity v and acceleration a .

Which quantities **must** be in the same direction?

- A a and v only
 B a and F only
 C v and F only
 D v , F and a
- 16 A hinged door is held closed in the horizontal position by a cable.
- Three forces act on the door: the weight W of the door, the tension T in the cable, and the force H at the hinge.

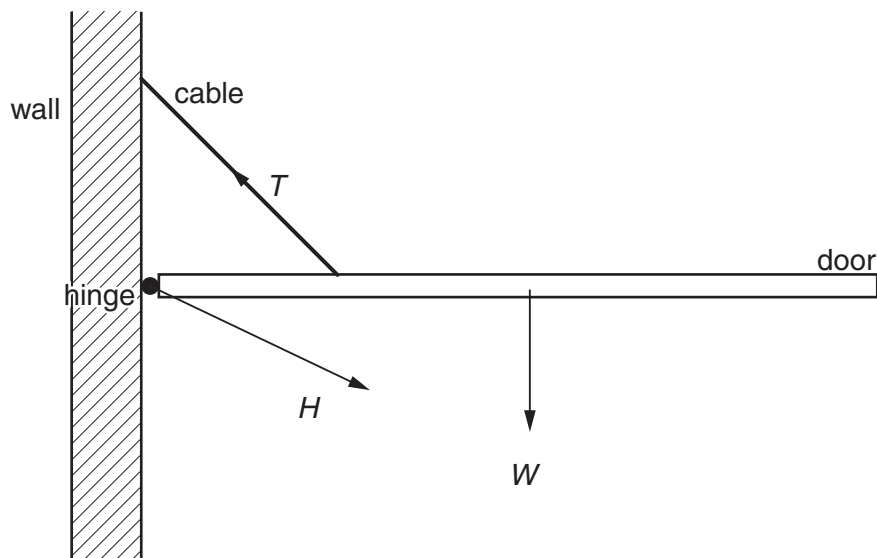

Which list gives the three forces in **increasing** order of magnitude?

- A H, T, W B T, H, W C W, H, T D W, T, H
- 17 A mass is raised vertically. In time t , the increase in its gravitational potential energy is E_p and the increase in its kinetic energy is E_k .

What is the average power input to the mass?

- A $(E_p - E_k)t$
 B $(E_p + E_k)t$
 C $\frac{E_p - E_k}{t}$
 D $\frac{E_p + E_k}{t}$

- 18 A boat moving at constant speed v through still water experiences a total frictional drag F .

What is the power developed by the boat?

- A $\frac{1}{2}Fv$ B Fv C $\frac{1}{2}Fv^2$ D Fv^2

- 19 The graph shows how the pressure exerted by a liquid varies with depth below the surface.

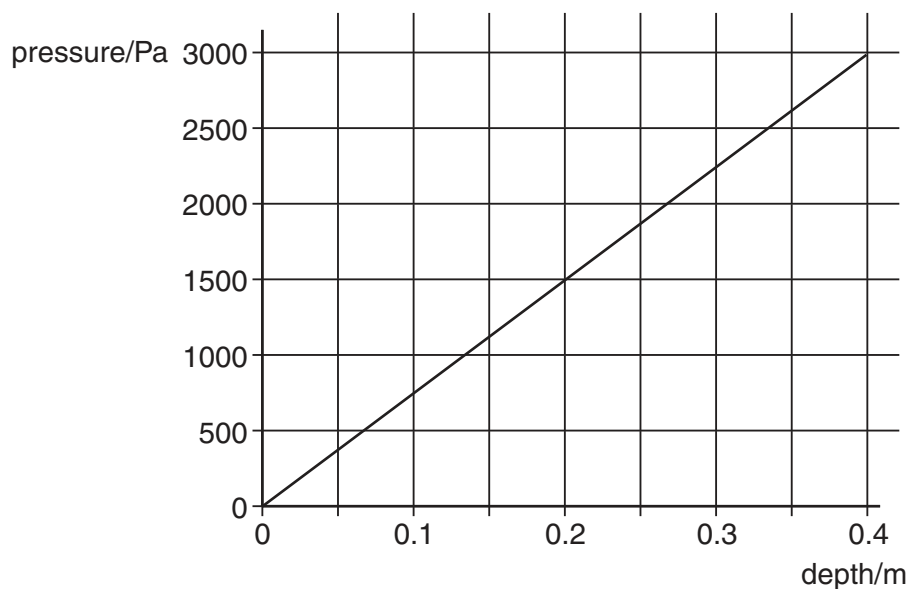

What is the density of the liquid?

- A 600 kg m^{-3} B 760 kg m^{-3} C 5900 kg m^{-3} D 7500 kg m^{-3}

- 20 In an experiment to demonstrate Brownian motion, smoke particles in a container are illuminated by a strong light source and observed through a microscope.

The particles are seen as small specks of light that are in motion.

What causes this motion?

- A collisions between the smoke particles and air molecules
 B collisions between the smoke particles and the walls of the container
 C convection currents within the air as it is warmed by the light source
 D kinetic energy gained by the smoke particles on absorption of light

21 What is the Young modulus of a metal?

- A extension / force
- B force / extension
- C strain / stress
- D stress / strain

22 The graph shows how the extension of a spring varies with the force used to stretch it.

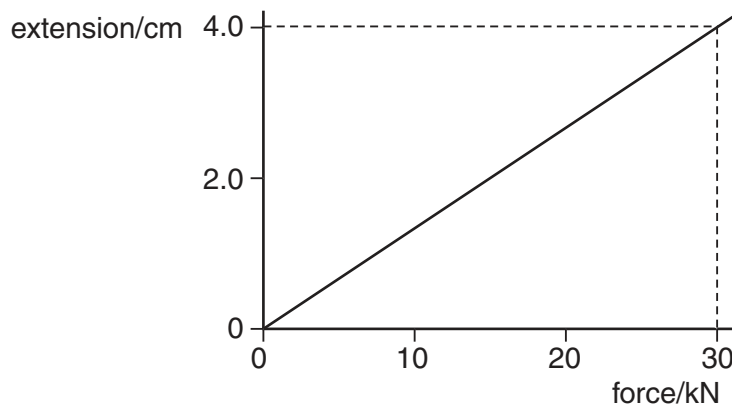

What is the strain energy stored in the spring when the extension is 4.0 cm?

- A 60 J
- B 120 J
- C 600 J
- D 1200 J

23 The graph shows how the displacement of a particle in a wave varies with time.

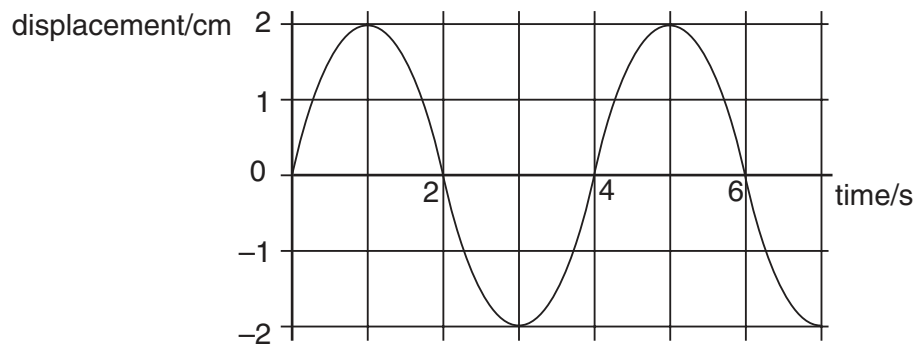

Which of the following is correct?

- A The wave has an amplitude of 2 cm and could be either transverse or longitudinal.
- B The wave has an amplitude of 2 cm and must be transverse.
- C The wave has an amplitude of 4 cm and could be either transverse or longitudinal.
- D The wave has an amplitude of 4 cm and must be transverse.

- 24 A stationary sound wave has a series of nodes. The distance between the first and the sixth node is 30.0 cm.

What is the wavelength of the sound wave?

- A** 5.0 cm **B** 6.0 cm **C** 10.0 cm **D** 12.0 cm

- 25 Which of the following applies to a progressive transverse wave?

	transfers energy	can be polarised
A	no	no
B	no	yes
C	yes	no
D	yes	yes

- 26 Which of the following may be used to produce stationary waves?

- A** blowing air over the top of an empty bottle
B making a loud sound near a mountain
C passing monochromatic light through a double slit
D passing water waves through a narrow slit

- 27 In an interference experiment, two slits are illuminated with white light.



What is seen on the screen?

- A** The central fringe is black with black and white fringes on each side.
B The central fringe is black with coloured fringes on each side.
C The central fringe is white with black and white fringes on each side.
D The central fringe is white with coloured fringes on each side.

- 28 Microwaves of wavelength 3.00 cm are incident normally on a row of parallel metal rods. The separation of the rods is 8.00 cm. The first order diffraction maximum is observed at an angle of 22.0° to the direction of the incident waves.

What is the angle between the first and second order diffraction maxima?

- A 22.0° B 26.6° C 44.0° D 48.6°
- 29 Which electrical quantity would be the result of a calculation in which energy is divided by charge?
- A current
B potential difference
C power
D resistance
- 30 A wire carries a current of 2.0 amperes for 1.0 hour.

How many electrons pass a point in the wire in this time?

- A 1.2×10^{-15}
B 7.2×10^3
C 1.3×10^{19}
D 4.5×10^{22}
- 31 The diagram shows a circuit in which the battery has negligible internal resistance.

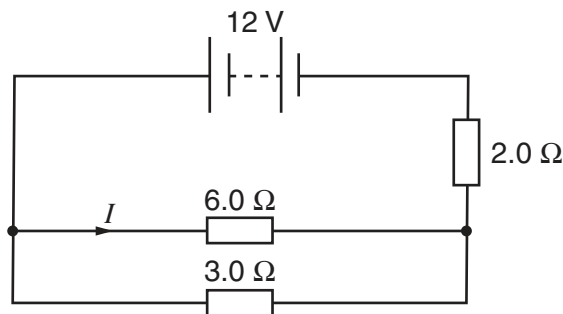

What is the value of the current I ?

- A 1.0 A B 1.6 A C 2.0 A D 3.0 A

32 The diagram shows currents I_1 , I_2 , I_3 , I_4 and I_5 in different branches of a circuit.

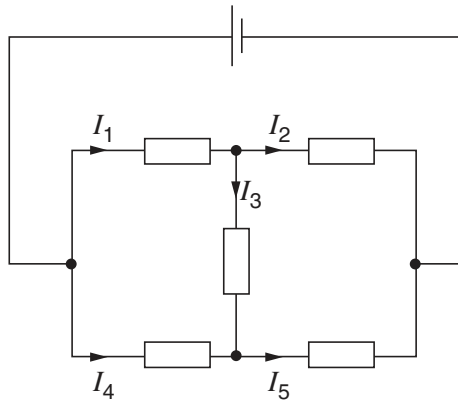

Which one of the following is correct?

- A $I_1 = I_2 + I_3$
- B $I_2 = I_1 + I_3$
- C $I_3 = I_4 + I_5$
- D $I_4 = I_5 + I_3$

33 Which diagram shows a potential divider circuit that can vary the voltage across the lamp?

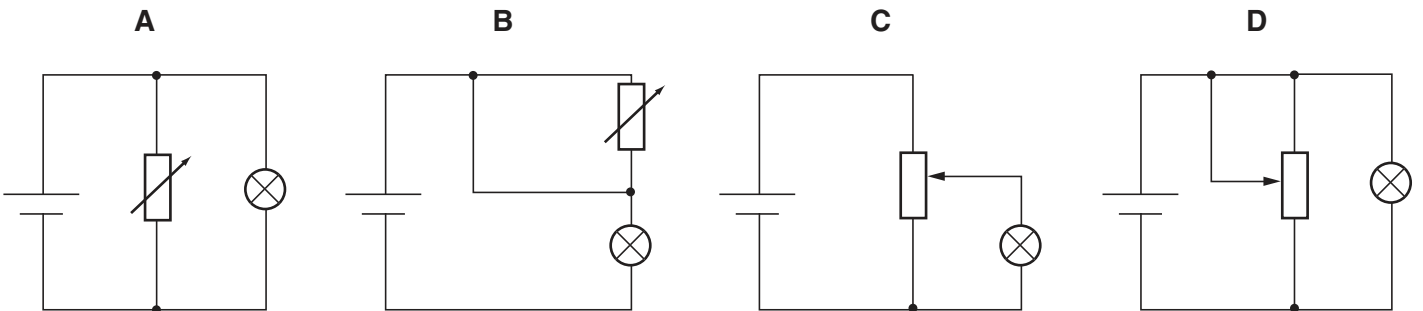

- 34 The diagram shows two circuits. In these circuits, only the internal resistances differ.

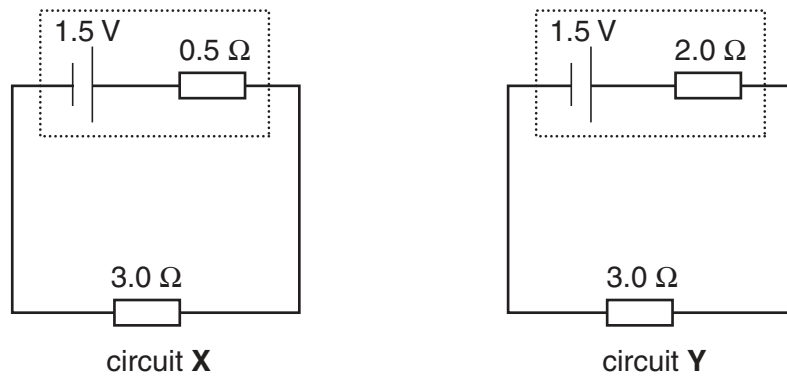

Which line in the table is correct?

	potential difference across 3.0 Ω resistor	power dissipated in 3.0 Ω resistor
A	greater in X than in Y	less in X than in Y
B	greater in X than in Y	greater in X than in Y
C	less in X than in Y	less in X than in Y
D	less in X than in Y	greater in X than in Y

- 35 Which diagram represents the electric field of a negative point charge $-q$?

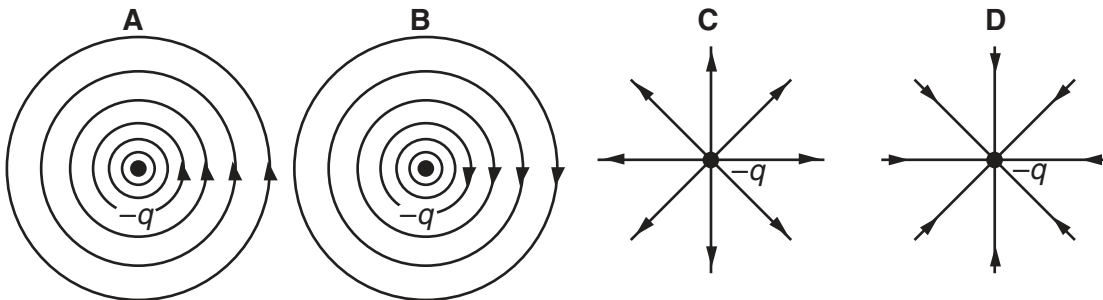

- 36 A potential difference V is applied between two parallel plates a small distance d apart, and produces an electric field of strength E between the plates.

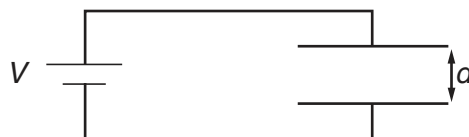

What is the electric field strength between the plates when both V and d are doubled?

- A** $E/4$ **B** E **C** $2E$ **D** $4E$

- 37 In the circuit below, the distance between the two parallel plates is $2.0 \times 10^{-3}\text{m}$. An electron is situated between the plates.

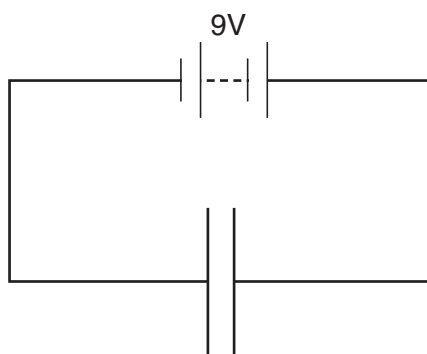

What is the force on the electron?

- A $3.2 \times 10^{-22}\text{ N}$
 B $2.9 \times 10^{-21}\text{ N}$
 C $8.9 \times 10^{-18}\text{ N}$
 D $7.2 \times 10^{-16}\text{ N}$
- 38 Which are the correct descriptions of a γ -ray and a β -particle?

	γ -ray	β -particle
A	high-speed electron	electromagnetic radiation
B	electromagnetic radiation	Helium-4 nucleus
C	electromagnetic radiation	high-speed electron
D	high-speed electron	Helium-4 nucleus

- 39 A certain nuclide, Uranium-235, has nucleon number 235, proton number 92 and neutron number 143. Data on four other nuclides are given below.

Which is an isotope of Uranium-235?

	nucleon number	proton number	neutron number
A	235	91	144
B	236	92	144
C	237	94	143
D	238	95	143

40 A nickel nucleus ${}_{28}^{59}\text{Ni}$ can be transformed by a process termed K-capture. In this process the nucleus absorbs an orbital electron.

If no other process is involved, what is the resulting nucleus?

- A ${}_{28}^{58}\text{Ni}$ B ${}_{27}^{58}\text{Co}$ C ${}_{27}^{59}\text{Co}$ D ${}_{29}^{59}\text{Cu}$

